

DATASHEET RFSG6H Specification v1.00

RF Signal Generator from 9 kHz to 6 GHz



4TECT

ООО «4TECT»
Телефон: +7 (499) 685-4444
info@4test.ru
www.4test.ru

DEFINITIONS

 The specifications in the following pages describe the warranted performance of the instrument for 23 ± 5 °C after a 30-minute warm-up period (unless otherwise stated).

Min/Max: Parameter range that is guaranteed by product design, and/or production tested. Warranted performance specifications include guard-bands to account for the expected statistical performance distribution, measurement uncertainties, and changes in performance due to environmental conditions.

Typical: Expected mean values, not warranted performance.

INTRODUCTION

 **Very compact, portable, high dynamic range analogue signal generator model from 9 kHz to 6 GHz.**

The RFSG6H is a RF signal generators covering a continuous a frequency range from 9 kHz up to 6 GHz with a 0.001 Hz resolution.

The RFSG6H provides an accurately levelled output power range and high spurious suppression. Advanced frequency synthesis with fractional-N divider makes for low SSB phase noise and micro-Hz resolution.

Available Options:

- **Option PE3** is an optional power level extension to accurately level below -120 dBm.
- **Option FS** substantially enhances the switching speed
- **Option 1URM** modifies form-factor to a 19" rack-mountable 1HU enclosure

SPECIFICATIONS

 PARAMETER	MIN	TYPICAL	MAX	NOTE
Frequency range	9 kHz		6.0 GHz	
resolution		0.001 Hz		
Phase resolution		0.1 deg		
Frequency / Amplitude settling time		200 μ s	300 μ s 30 μ s	option FS
SSB Phase noise standard				
500 MHz				
10 Hz offset		-86 dBc/Hz		
1 kHz offset		-126 dBc/Hz		
100 kHz offset		-137 dBc/Hz		
4 GHz				
10 Hz offset		-68 dBc/Hz		
1 kHz offset		-108 dBc/Hz		
100 kHz offset		-119 dBc/Hz		
Wideband noise		-150 dBc/ Hz		
Output power				
Standard				
< 10 MHz	-30 dBm		+20 dBm	
>= 10 MHz			+25 dBm	

Option PE3 < 10 MHz ≥ 10 MHz	-120 dBm		+20 dBm +24 dBm	
Level resolution		0.01 dB		
Level uncertainty, ALC on		0.3 dB 0.6 dB 1.5 dB 2.0 dB	1.0 dB 1.5 dB	-20 to +15 dBm -65 dBm to -20 dBm -100 to -65 dBm < -100 dB
Temperature effects		0.015 dB/ °C		< -0 to 45 °C
User flatness correction		up to 2000 points		
Output impedance VSWR		50 Ω 1.5 2.0		< 20 GHz > 20 GHz
Reverse Power Protection				
DC Voltage			±15 V	
RF power			30 dBm	
Spectral purity at + 5 dBm				
Output harmonics		-40 dBc	-30 dBc	See plot
Sub-harmonics		-75 dBc -50 dBc	-65 dBc -40 dBc	< 20 GHz > 20 GHz
Non-harmonic spurious < 312 MHz > 312 to 625 MHz > 625 MHz to 1.5 GHz > 1.5 GHz to 2.5 GHz > 2.5 GHz to 6 GHz		-80 dBc -75 dBc -75 dBc -70 dBc -65 dBc	-66 dBc -70 dBc -65 dBc -65 dBc -60 dBc	CW +10 dBm, > 3 kHz offset

Sweeping Capability

Sweeps can be performed with combined internal or external AM/FM/PM/pulse modulation running. With modulation enabled, the minimum step time increases to 2 ms.

PARAMETER	MIN	TYPICAL	MAX	NOTE
Digital power / frequency / list sweeps				
Sweep type: linear, logarithmic, random				
Step time (τ_{step})	400 μ s 40 μ s		19998 s	Option FS
Dwell time (τ_{val})	10 μ s		9999 s	
Off-time (incl. transient time) (t_{off})	0		9999 s	
Transient time (τ_{inv})			270 μ s 30 μ s	Option FS
Timing delay (τ_{de})		2 to 10 μ s 50 ns		Option FS
Time resolution		0.1 μ s 5 ns		Option FS
Timing accuracy per point		3 μ s 5 ns		Option FS

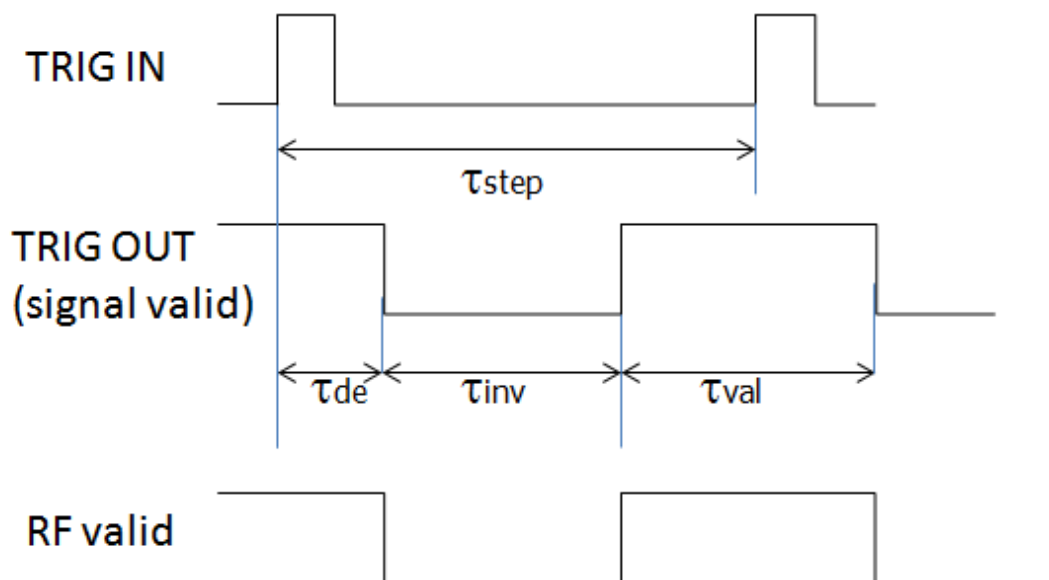

Frequency Chirps

(linear ramp, up/down)

Bandwidth	10 %			of carrier frequency
Dwell time (t_{dwell})	10 ns		10000 μ s	
Slope			100 MHz / μ s	
Number of frequencies			65'000	



Reference Frequency

REF IN input and REF OUT output are at rear panel

PARAMETER	MIN	TYPICAL	MAX	NOTE
Internal reference frequency		100 MHz		
Initial accuracy			±40 ppb	calibrated at 23 ± 3 °C at time of calibration, user adjustable
Temperature stability (0 to 50 degC)			±100 ppb	
Aging 1 st year		0.5 ppm		
Aging per day (after 30days operations)			5 ppb	
Warm-Up time		5 min		
Output of internal reference		10 MHz 10/100 MHz		
Output power		0 dBm		
Output impedance		50 Ω		
Bypass Internal reference Input	100 MHz, -5 to +10 dBm			High phase synchronous mode
Phase Lock to External Reference External Input Range	1 MHz		250 MHz	User programmable
Reference input level	-5 dBm	0 dBm	+13 dBm	
Lock Range			±1.5 ppm	
Reference input impedance		50 Ω		



Multi-Purpose Output (FUNC OUT)

Output is FUNC OUT at rear panel

PARAMETER	MIN	TYPICAL	MAX	NOTE
MULTIFUNCTION GENERATOR				
sine, triangle, square wave				
Frequency range	1 Hz 1 Hz		3 MHz 1 MHz 50 kHz	sine triangle square
Frequency resolution		0.1 Hz		
Output voltage amplitude peak-peak	10 mV	5V	2 V	Sine, triangle Square (CMOS output)
Harmonic Distortion		1%		< 100 kHz, 1 Vpp
Output impedance		50 Ω CMOS		Sine, triangle square wave
VIDEO OUTPUT (of internal pulse modulator)				
Output		CMOS		
Period	30 ns		50 s	
Pulse Width	15 ns		50 s	
RF delay		10 ns		
TRIGGER OUT Synchronization mode for multiple sources				
Modes	Trigger on sweep start Trigger on each point Signal Valid			Option FS

Trigger (TRIG IN)

Input is TRIG IN at rear panel

PARAMETER	MIN	TYPICAL	MAX	NOTE
Trigger Types	Continuous, single, gated, gated direction			
Trigger Source	RF key, external, bus (GPIO, LAN, USB)			
Trigger Modes	Continuous free run, trigger and run, reset and run			
Trigger latency		2 μ s 5 ns		Option FS
Trigger uncertainty		5 μ s 10 ns		Option FS
External Trigger delay	50 μ s 50 ns		40 s 10 s	programmable Option FS
External Delay Resolution		15 ns 10 ns		Option FS
Trigger Modulo	1		255	Execute only on Nth trigger event
Trigger Polarity	Rising, falling			
External trigger input threshold	0.85 V	0.9 V	0.95 V	TTL compatible
External trigger input voltage range	-0.5 V		+5.5 V	TTL compatible
External trigger input hysteresis		60 mV		

Trigger Output (TRIG OUT)

see Multi-Purpose Output (FUNC OUT)

Modulation Capabilities

Combination of AM/PM/FM/PULSE are possible. See user manual for more details.

PARAMETER	MIN	TYPICAL	MAX	NOTE
Multifunction Generator				
sine, triangle, square wave				
Output is FUNC OUT at rear panel				
Frequency range	10 Hz 10 Hz		3 MHz 1 MHz 50 kHz	sine triangle square
Frequency resolution		0.1 Hz		
Output voltage amplitude peak-peak	10 mV	5V	2 V	Sine, triangle Square (CMOS output)
Harmonic Distortion		1%		< 100 kHz, 1 Vpp
Output impedance		50 Ω CMOS		Sine, triangle square wave
Pulse Modulation				
On/off ratio		75 dB (typical)		at +10 dBm
Repetition frequency	DC		10 MHz	
Pulse width	100 ns 500 ns		5 s 5 s	ALC hold ALC on

Pulse rise/fall time		7 ns		
Duty cycle	0.05%		99.95%	
Pulse resolution		15 ns		
Polarity		selectable		
External input threshold	0.85 V	0.9 V	0.95 V	TTL compatible
External input voltage range	-0.5 V		+5.5 V	TTL compatible
External input hysteresis		60 mV		
Delay (to RF)		20 ns	40 ns	
Pulse Pattern Modulation				Using internal pattern generator at +10 dBm
On/off ratio		75 dB		
Pulse bit width	30 ns 500 ns			ALC hold ALC on
Pulse rise/fall time		30 ns 7 ns		<5 GHz >5 GHz
Programmable pattern length	2		4192	
Duty cycle	0.05%		99.95%	
Pulse bit resolution		30 ns 10 ns		Option FS
Polarity		selectable		
Frequency Modulation				
Maximum Frequency deviation (peak)		$> 0.05 \cdot f$ $N \cdot 200 \text{ MHz}$		$< 1.25 \text{ GHz}$ 1.25 GHz to 2.5 GHz (N=0.125) 2.5 GHz to 5 GHz (N=0.25) 5 GHz to 10 GHz (N=0.5) > 10 GHz to 20 GHz (N=1)
Deviation accuracy < 100 kHz rate > 100 kHz rate		0.5% 2%	2% 5%	
Distortion		< 1%		1 kHz rate, 50 kHz deviation
Modulation rate	DC		800 kHz	> -3dB frequency response
Modulation waveforms	Sine, triangle, FSK			
External input sensitivity AC coupled DC coupled		0 to N · 200 MHz / V 0 to N · 100 MHz / V		adjustable for ±1 V range discr. values; ±5 V range
Total harmonic distortion		< 1%		1 kHz rate & N · 1 MHz deviation
Phase Modulation				
Phase deviation (peak)	0		N·300 rad	
Modulation rate	DC		800 kHz	> -3dB frequency response Max. phase deviation degrades above 20 kHz modulation rate
Modulation waveforms	Sine, triangle, FSK			
External Input sensitivity	Settable 0.1 rad/V to 360 rad/V			
Total harmonic distortion		< 1%		1 kHz rate & N x 100 rad deviation
Amplitude Modulation				

Modulation rate	0.1 Hz		50 kHz	
Modulation waveforms	Sine, triangle, square			
Modulation depth	0%		90%	settable
Distortion (sine wave)		2%	7%	at 60% modulation depth

PERFORMANCE CURVES

Typical performance curves Phase Noise Performance (10 Hz to 100 MHz offset) at different frequencies

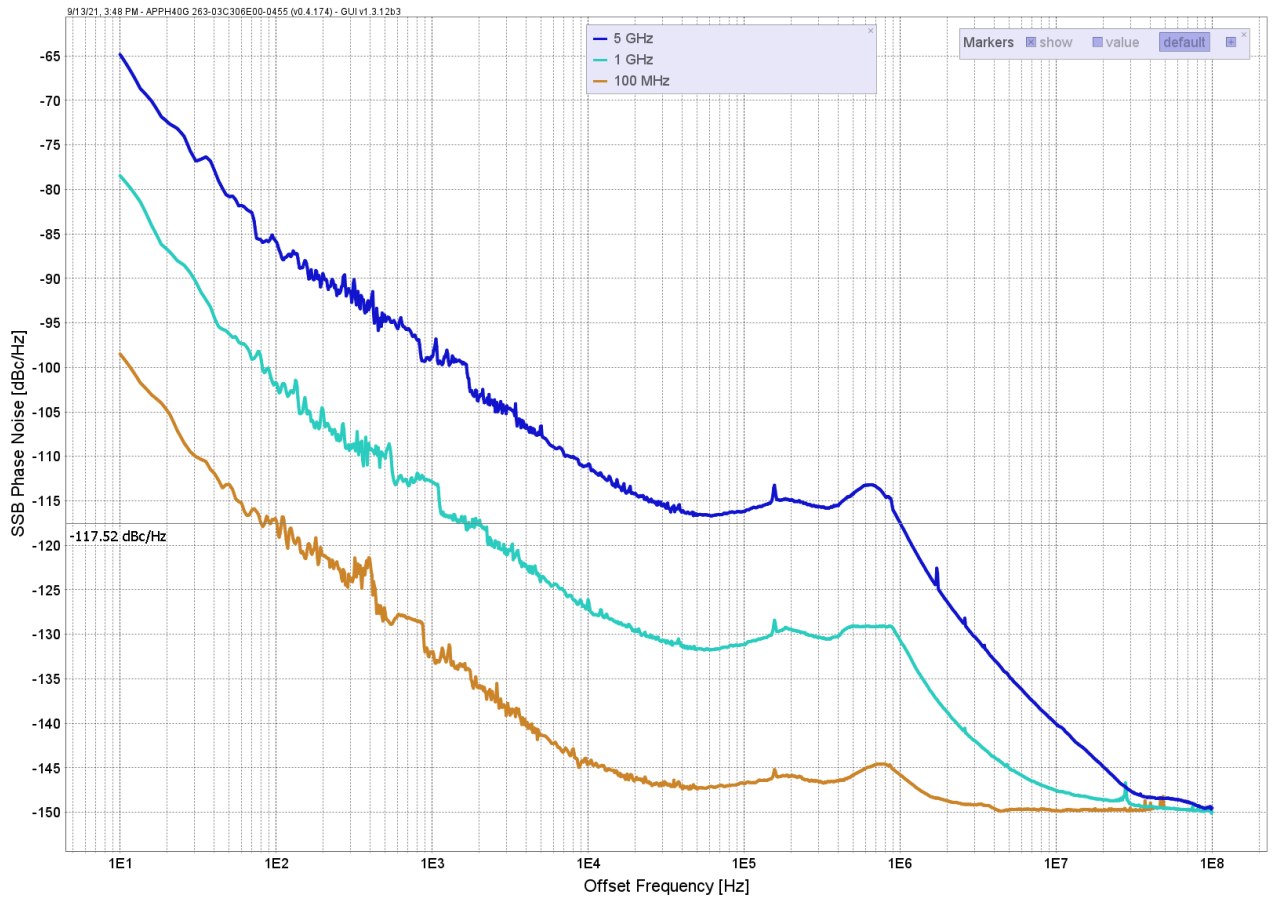

Typical Frequency Response 0.01 to 6 GHz

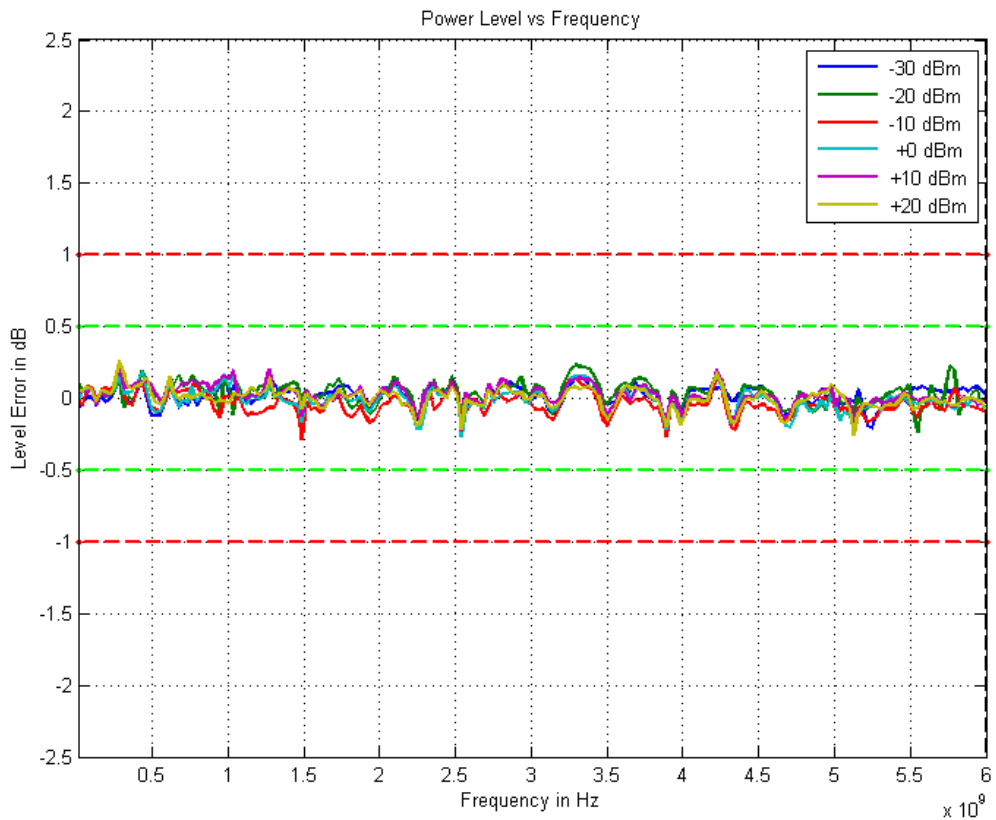

Typical Maximum Output Power (with option PE3)

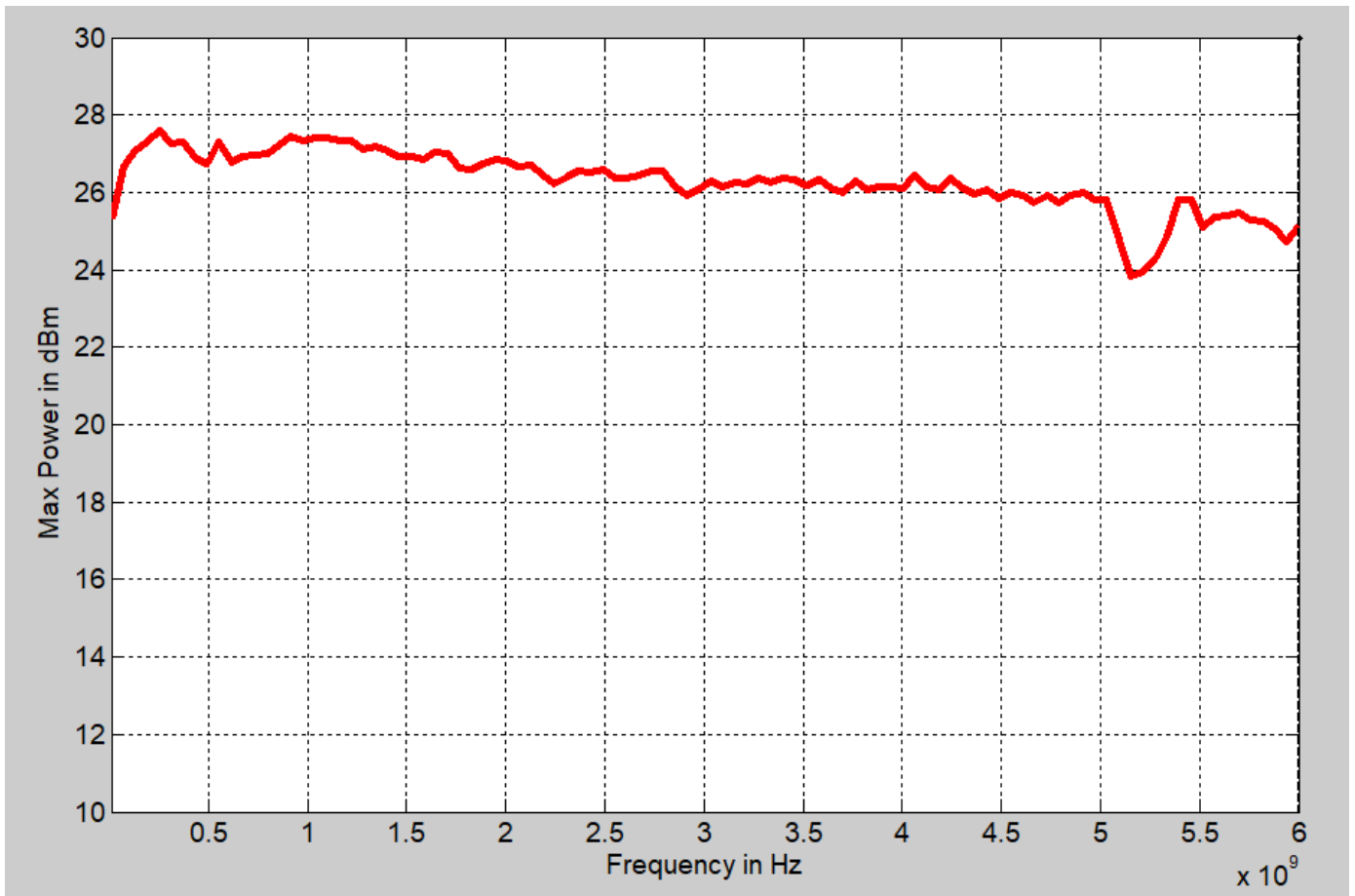

Typical Maximum Output Power (no option)

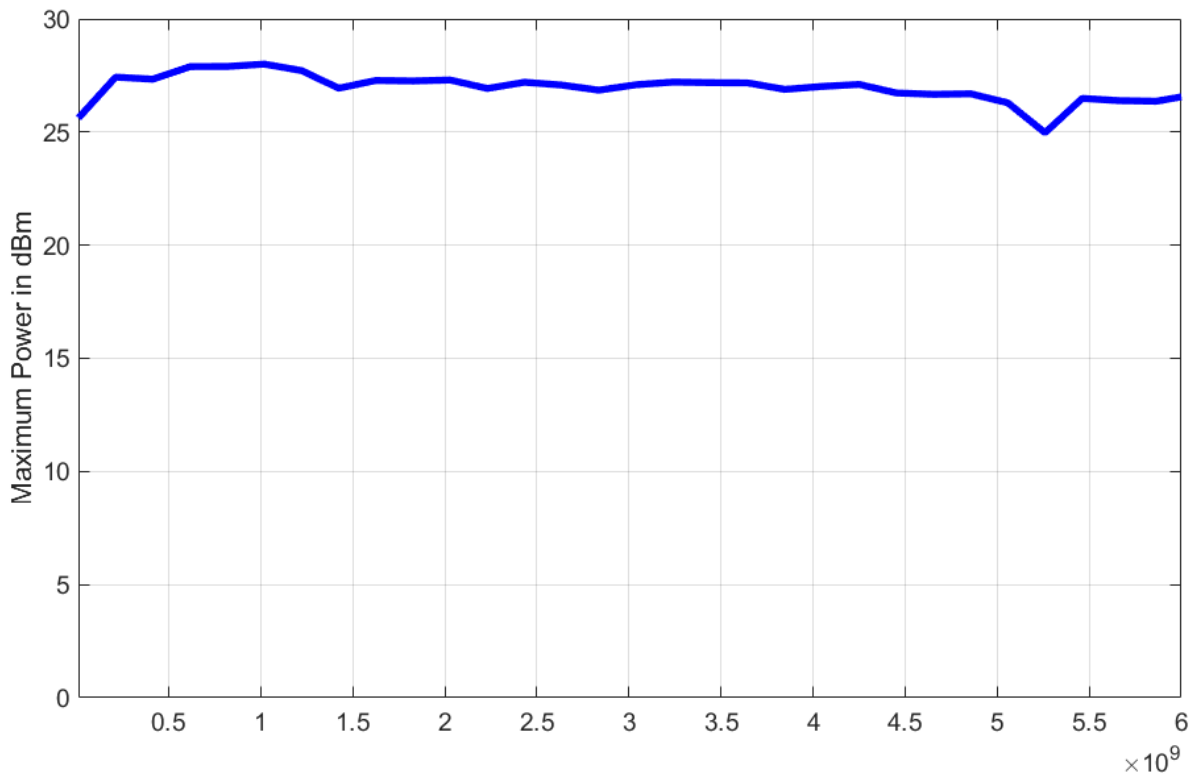

Typical Maximum Output Power from 9 kHz to 100 kHz

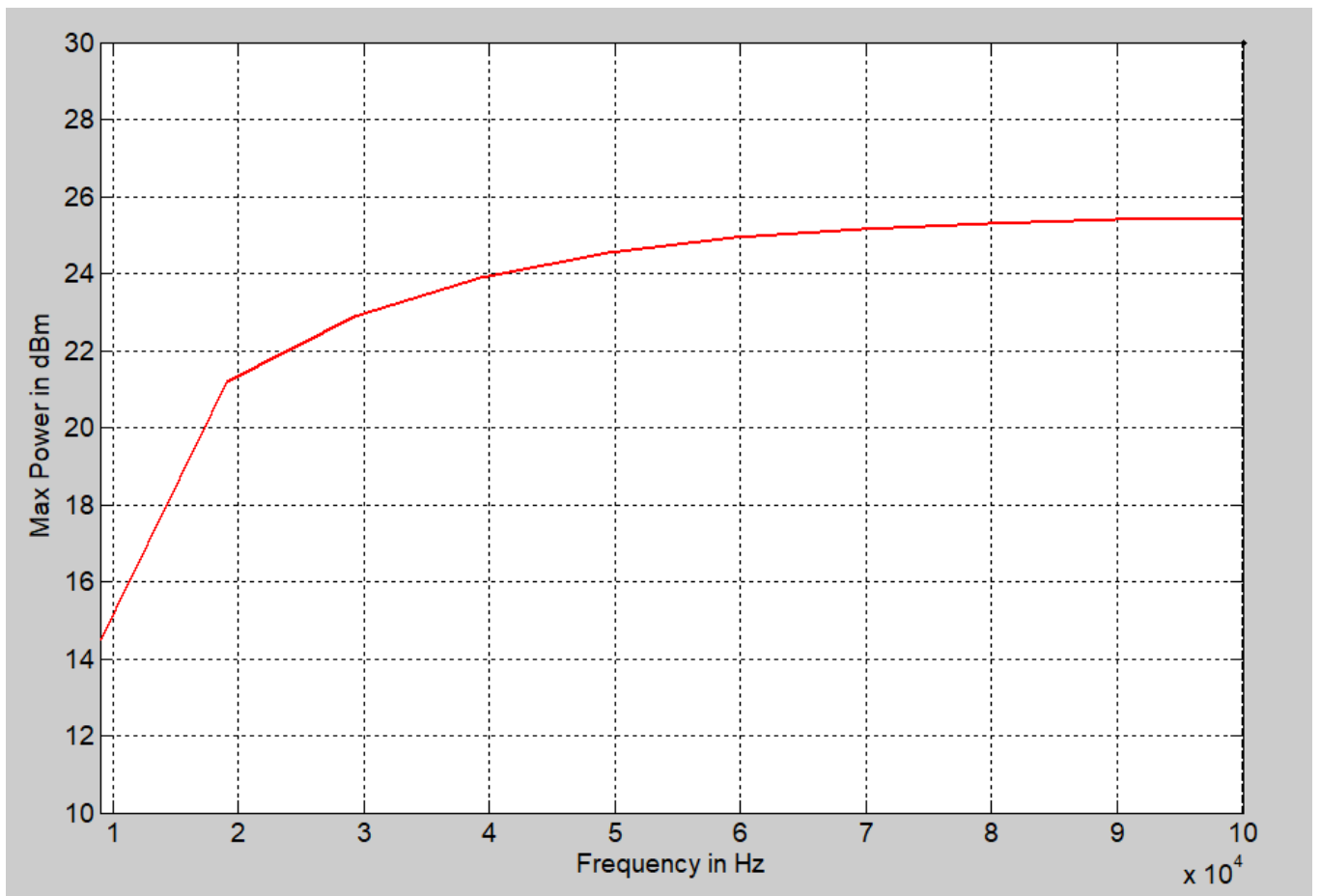

Harmonics (5 dBm)

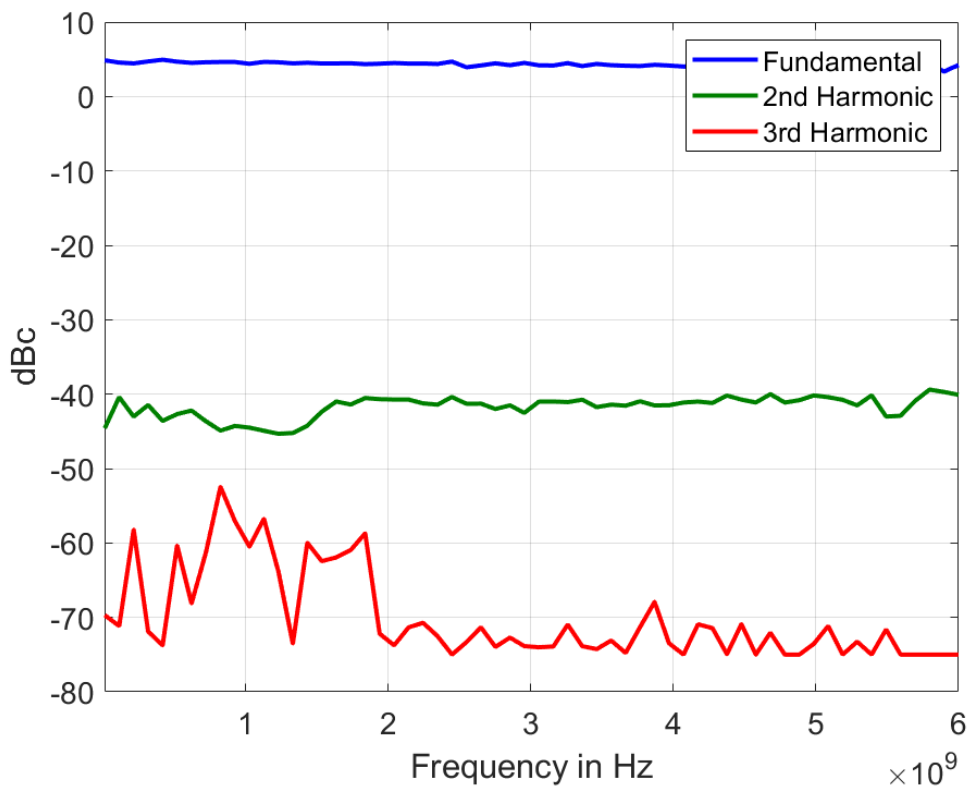

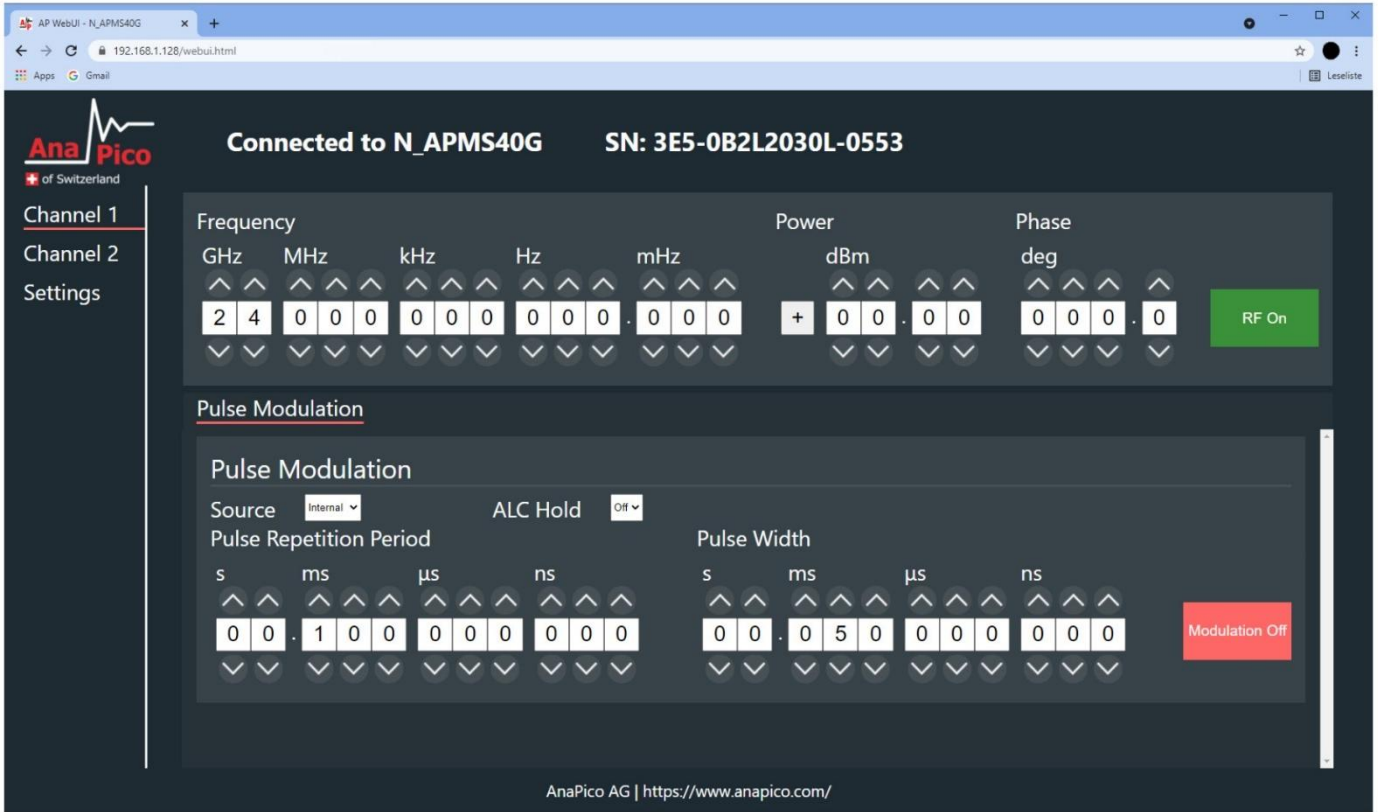

The screenshot displays the AnaPico web browser GUI. At the top, it shows the browser address bar with the URL `192.168.1.128/webui.html`. The main interface is dark-themed and includes a sidebar on the left with navigation options: **Channel 1**, **Channel 2**, and **Settings**. The main content area is titled **Connected to N_APMS40G** with a serial number **SN: 3E5-0B2L2030L-0553**.

The **RF On** section contains three primary settings:

- Frequency:** Set to 2400000000 Hz (2.4 GHz).
- Power:** Set to +00.00 dBm.
- Phase:** Set to 000.0 deg.

The **Pulse Modulation** section includes:

- Source:** Internal
- ALC Hold:** Off
- Pulse Repetition Period:** Set to 1000 ns (1 μs).
- Pulse Width:** Set to 0500 ns (0.5 μs).

Buttons for **RF On** (green) and **Modulation Off** (red) are visible on the right side of their respective sections. The footer of the interface reads **AnaPico AG | <https://www.anapico.com/>**.



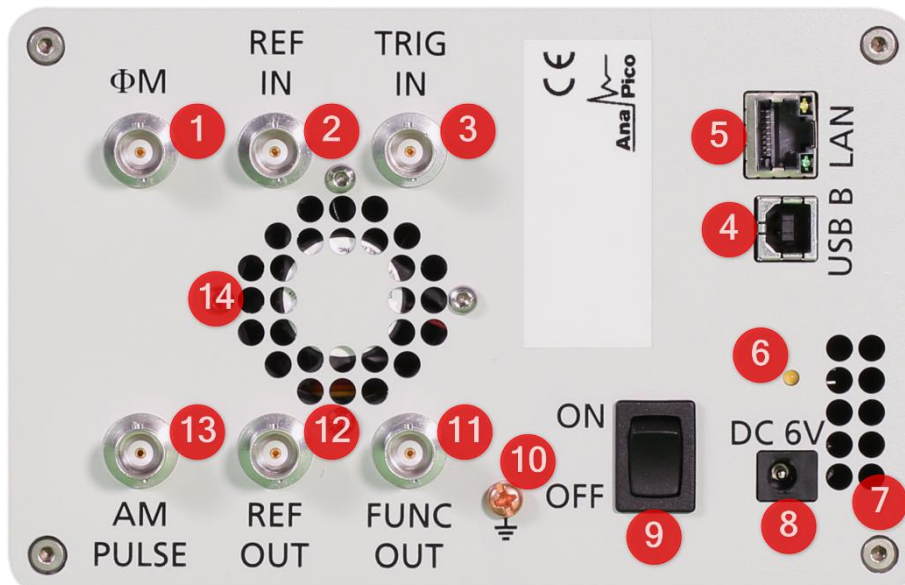

1. **Rotary Button** The rotary button is used to change the value selected on the screen.
2. **RF 50 Ω connector** This female N- type respectively SMA connector provides the output for generator signals. The impedance is 50 ohm. The reverse power damage level is +30 dBm maximum. The maximum allowed DC level is +/- 10 V. Please check the data sheets for more details.

Rear

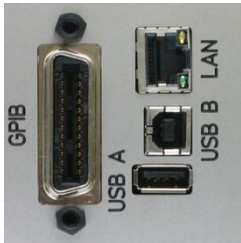

1. **ΦM** This BNC female Connector is the input for FM and PM.
2. **REF IN** This BNC female Connector is the input for the reference signal.
3. **TRIG IN** This BNC female Connector is the trigger input.
4. **USB B** The USB B connector is used to connect the device to a computer.
5. **LAN** The LAN connector is used to connect the device to a network.
6. **Battery LED** In case the device has a rechargeable battery, this LED indicates whether the battery is charged or not.
7. **Fan Holes** The air intake of the fan.
8. **Power Supply** Connect the Anapico power adaptor to this connector to supply the device with energy.
9. **ON/OFF Switch** Turns the device on or off.
10. **Ground Screw**
11. **FUNC OUT** This BNC female Connector is the output for the function signal.
12. **REF OUT** This BNC female Connector is the output for the reference signal.
13. **AM PULSE** This BNC female Connector is the input for the AM and the PULSE Modulation signal.
14. **Fan Holes** The holes by which the air is extruded.

ORDERING INFORMATION

HOST MODEL	PRODUCT	DESCRIPTION
RFSG6H	RFSG6H	6 GHz RF Signal Generator
RFSG6H	Option PE3	Mechanical step attenuator
RFSG6H	Option FS	Ultra-fast switching speed
RFSG6H	Option FLASH	MicroSD card slot for removable SD memory
RFSG6H	Option DATA	Commercial Calibration Certificate with test data
RFSG6H	Option IEC	IEC 17025 calibration with certificate
RFSG6H	Option Bag	Portable Bag
RFSG6H	Option GPIB*	GPIB interface 
RFSG6H	Option EB6	External power bank adapter cable with voltage converter for 12 to 25 V supply Required input connector: Inner / outer diameter 2.1 / 5.5 mm 
RFSG6H	Option 1URM	19" 1HU rack-mount module  Dimensions 42 mm H x 426 mm W x 460 mm L [1.7 in H x 16.8 in W x 18.1 in L]
RFSG6H	Option RM	19" 3HU rack-mount kit
RFSG6H	Option REAR	Move output to rear panel
RFSG6H	Option OEM	OEM package
RFSG6H	Option WE	One year warranty extension (standard: 2 years)
RFSG6H	Option ReCal	Recalibration with test data (recommended: 2 years interval)
RFSG6H	Option Retrofit	Applies when options are back-ordered

GENERAL CHARACTERISTICS

Remote programming interfaces

Ethernet 100BaseT LAN interface,
USB 2.0 host & device
GPIB (IEEE-488.2,1987) with listen and talk (optional)
Control language SCPI Version 1999.0

Power requirements 6.25 ± 0.2 VDC; 20 W maximum

Main adapter supplied: 100-240 VAC in/ 6 V 6.0 A DC out

Environmental (Levels similar to MIL-PRF-28800F Class 3/4)

Environmental stress Samples of this product have been type tested to be robust against the environmental stresses of storage, transportation, and end-use; those stresses to temperature, humidity, shock, vibration, altitude, and power line conditions.

Operating temperature range 0 to 40 °C

Storage temperature range -40 to 70 °C

Operating and storage altitude up to 15,000 feet (4600 m)



EMC complies and EMC regulations and directives for emission and immunity to interference (EN 61326-1 Industrial, EN/IEC 61326-2-1)

Safety complies with applicable Safety regulation in line with IEC/EN 61010-1

Weight ≤ 2.5 kg (6 lbs) net, ≤ 4 kg (8 lb.) shipping

Dimensions

116.9 mm H x 173.6 mm W x 261.7 mm L (incl. connectors)

[4.60 in H x 6.83 in W x 10.30 in L]

Recommended calibration cycle 24 months



ООО «4TECT»

Телефон: +7 (499) 685-4444

info@4test.ru

www.4test.ru